

kinetik™

*Kinetik Labs
KISP-C160-LP*

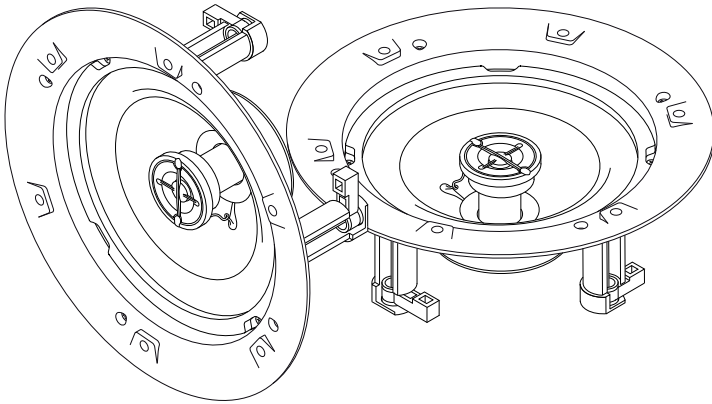

*In-Ceiling Speakers
Instruction Manual*



Kinetik Labs
KISP-C160-LP

In-Ceiling Speakers

Contents

Section	Page
Introduction	3
Safety Instructions	3
Description	3
Box Contents	4
Installation Instructions	5
Speaker Removal	7
Painting Speakers	7
Additional Features	8
Specifications	9
Limited Warranty	10



Kinetik Labs
KISP-C160-LP

In-Ceiling Speakers

Introduction

Thank you for purchasing these Kinetik Labs speakers. Please read these instructions carefully to complete your installation quickly and efficiently for trouble free installation.

Safety Instructions



- **Caution:** Installation should be carried out and checked before providing power to the system. Damage caused by improper wiring or installation is not covered by the warranty.
- Keep this product away from small children and animals as it contains small parts.
- Keep this product away from naked flames and sources of ignition including lighting. Building regulations may require that you install a fire hood.

Description

The KISP-C160-LP is designed for installation in ceilings, or other suitable surfaces such as plasterboard walls. It is a two way array design with 160mm Polypropylene bass/mid driver and 13mm mylar dome tweeter.

Box Contents

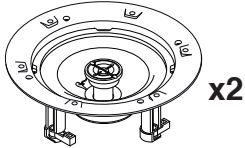

KISP-C160-LP In-ceiling speaker

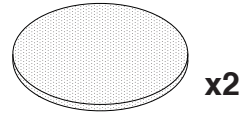

Speaker grille

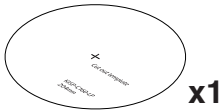

Cutout template



Instruction manual

Installation Instructions

- ⚠ Be careful when handling the speaker. It is okay to hold using the tweeter pole but do not touch the drive unit as it could result in damage.

1.

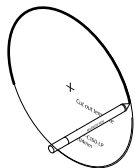

Using the cut out template, draw a 204mm circle on the ceiling / wall, where you wish to install the speaker.

- ⚠ Ensure there are no joists in the way.

2.

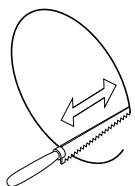

Cut out a hole using a suitable saw or hole cutting tool.

- ⚠ Be careful not to cut through wiring or pipes.

3.

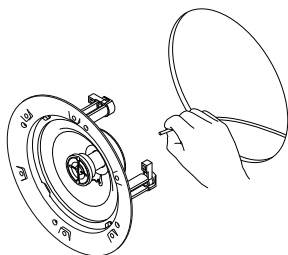

Now pull through the speaker cable and connect it to the spring clip connectors located on the rear of the speaker.

To do this, press down on each spring clip and feed the bare cable wire into the hole. Releasing the clip will lock the wire in place.

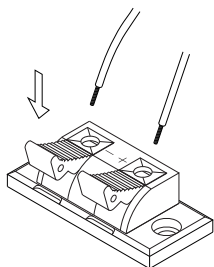

- ⚠ Make sure you connect the speaker cable to the corresponding + / - outputs from the amplifier.

Installation Instructions (continued)

4.

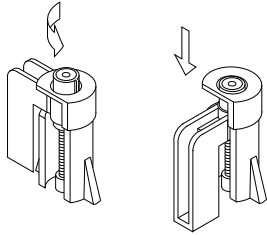
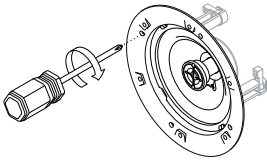

Place each speaker into the hole, with the black plastic dog legs on the rear of the speaker tucked in, and tighten the four screws with a Phillips-head screwdriver.

The dog legs will turn and lock the speaker into the ceiling / wall. The fixing should be firm but do not overtighten as this can strip the thread and cause difficulties for speaker removal.

5.

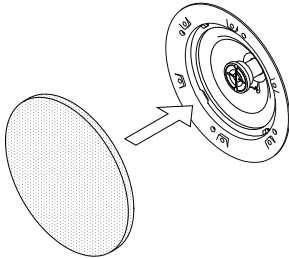

When you are happy the system is working, apply the speaker grille to the speaker. The magnets will hold the grille in place.

Repeat these steps for all speakers.

Speaker Removal

1.

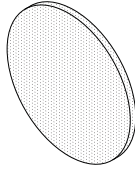

Holding the edges, pull the speaker grille from the wall or ceiling to release it from the magnets.

2.

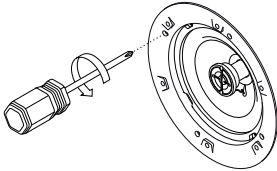

Unscrew the four screws around the speaker rim and hold it securely as it loosens. The dog legs should automatically retract.

3.

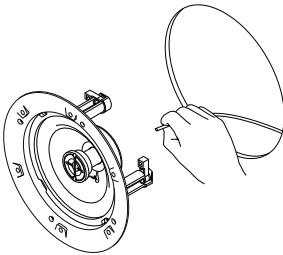

To release the speaker, gently pull it out from the hole and disconnect the speaker cable from the binding posts.

Painting Grille

This speaker has a paintable grille which must be decorated separately and with the correct methods to avoid directly painting or damaging the drivers.

Peel off the material which has been preapplied to the rear of the speaker grille. When spraying it, use suitable methods to ensure the holes are not blocked.

Specifications

General

Model Number:	KISP-C160-LP
Box contents:	2x in-ceiling speakers 2x speaker grilles
Included accessories:	1x cut out template 1x instruction manual

Mechanical

Woofer:	160mm polypropylene cone with UV treated foam surround, 25mm voice coil
Tweeter:	13mm mylar dome
Tweeter protection:	Polyimide auto protective reset switch
Recommended amplification:	10-125W
Maximum power:	125W
Impedance:	8 Ohm
Sensitivity:	88dB
Frequency response:	55-22,000Hz
Weight (per speaker):	1.07kg
Packed Weight:	2.4kg
Cutout size:	204mm
Mounting depth:	86mm
Maximum surface thickness:	33mm

Dimensions

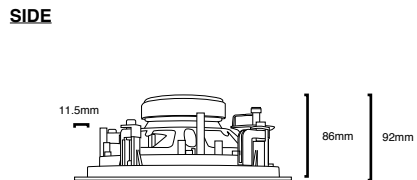
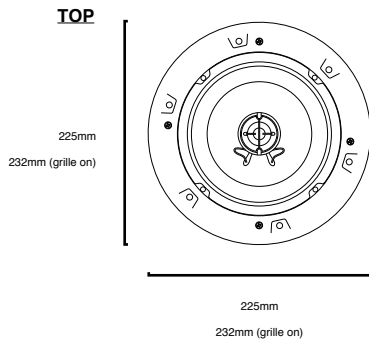

Limited Warranty

This Kinetik Labs product is warranted free of defects in workmanship and materials on purchase. If the goods are found to be defective within the warranty period, they will be repaired or replaced, at AWE Europe Ltd's option, without charge on return to the vendor upon satisfactory proof of purchase from the vendor and date of purchase. This warranty does not apply if, in the judgement of AWE Europe Ltd, the product fails due to damage from shipment, handling, storage, accident, abuse, or misuse, or if it has been used or maintained in a manner not conforming to product manual instructions, has been modified in any way, or has had any serial number removed or defaced. Repair by anyone other than AWE Europe Ltd or an approved agent will void this warranty. The maximum liability of AWE Europe Ltd under this warranty is limited to the purchase price of the product covered by the warranty. AWE Europe Ltd shall not under any circumstances be liable to any person for any special, incidental, indirect or consequential damages, including without limitation, damages resulting from use or malfunction of the products, loss of profits or revenues or costs of replacement goods, even if AWE Europe Ltd is informed in advance of the possibility of such damages.

In the first instance consumers should contact their vendor.
Territorial distributor details can be found at www.kinetiklabs.com

kinetik™

www.kinetiklabs.com

© Copyright AWE Europe Ltd 2011. All rights reserved. Design and specifications are subject to change without prior notice. No part of this document may be reproduced, for any purpose, without prior written permission from AWE Europe Ltd. AWE Europe Ltd is not liable for omissions or for technical or editorial errors herein or for damages directly or indirectly resulting from the use of this Kinetik Labs product. 'Kinetik Labs' and the 'Kinetik' logo are trademarks of AWE Europe Ltd.

